



8e6® Threat Analysis Reporter

QUICK START GUIDE



Model: TAR
MSA-004-004

Release: 1.1.15 / Updated: 02.29.08

8E6 ENTERPRISE FILTER QUICK START GUIDE

© 2008 8e6 Technologies. All rights reserved.

This document may not, in whole or in part, be copied, photocopied, reproduced, translated, or reduced to any electronic medium or machine readable form without prior written consent from 8e6 Technologies.

Every effort has been made to ensure the accuracy of this document. However, 8e6 Technologies makes no warranties with respect to this documentation and disclaims any implied warranties of merchantability and fitness for a particular purpose. 8e6 Technologies shall not be liable for any error or for incidental or consequential damages in connection with the furnishing, performance, or use of this manual or the examples herein. The information in this documentation is subject to change without notice.

The R3000 products have been tested and found to comply with the limits for a Class A digital device, pursuant to part 15 of the FCC Rules. These limits are designed to provide reasonable protection against harmful interference when the equipment is operated in a commercial environment. This equipment generates, uses, and can radiate radio frequency energy and, if not installed and used in accordance with the instruction manual, may cause harmful interference to radio communications. Operation of this equipment in a residential area is likely to cause harmful interference in which case the user will be required to correct the interference at his own expense.

Trademarks

Other product names mentioned in this manual may be trademarks or registered trademarks of their respective companies and are the sole property of their respective manufacturers.

Part# TAR-MSAul-QSG-080229

CONTENTS

THREAT ANALYSIS REPORTER INTRODUCTION	1
About this Document	2
Conventions Used in this Document.....	2
SERVICE INFORMATION	3
PRELIMINARY SETUP PROCEDURES	4
Unpack the Unit from the Carton	4
Select a Site for the Server	5
Rack Mount the Server.....	6
Check the Power Supply.....	15
General Safety Information.....	16
INSTALL THE SERVER	19
Step 1: Initial Setup Procedures	19
Step 1A: Step-by-Step Setup Procedures	19
Step 2: Wizard Setup Procedures	35
CONCLUSION	47
LED INDICATORS AND BUTTONS	48
MSA Units.....	48
REGULATORY SPECIFICATIONS AND DISCLAIMERS	49
Declaration of the Manufacturer or Importer	49
APPENDIX: OPTIONAL ETHERNET TAP INSTALLATION	51
Preliminary Setup Procedures	51
Install the Ethernet Tap Unit	52
INDEX	54

THREAT ANALYSIS REPORTER INTRODUCTION

Thank you for choosing to evaluate the 8e6 Technologies Threat Analysis Reporter. This product addresses user-generated Web threats such as excessive use of bandwidth and inappropriate Internet usage, and provides network administrators tools to monitor such threats so management can enforce corporate Internet usage policies.

Working in conjunction with 8e6's R3000 Enterprise Filter, the Threat Analysis Reporter translates end user Internet activity from the R3000's logs into dynamic graphical snapshots of network Internet traffic. Using remediation tools in the console, administrators and management can then manage and control user-generated Web threats in real time.

About this Document

This document is divided into the following sections:

- **Introduction** - This section is comprised of an overview of the Threat Analysis Reporter product and how to use this document
- **Service Information** - This section provides 8e6 Technologies contact information
- **Preliminary Setup Procedures** - This section includes instructions on how to physically set up the Threat Analysis Reporter unit in your network environment
- **Install the Server** - This section explains how to configure the Threat Analysis Reporter
- **Conclusion** - This section indicates that the quick start steps have been completed
- **LED Indicators and Buttons** - This section explains how to read LED indicators and use LED buttons for troubleshooting the unit
- **Regulatory Specifications and Disclaimers** - This section cites safety and emissions compliance information for the TAR model referenced in this document
- **Appendix: Optional Ethernet Tap Installation** - This appendix explains how to install the optional Ethernet Tap device on your network for bandwidth monitoring
- **Index** - An alphabetized list of some topics included in this document

Conventions Used in this Document

The following icons are used throughout this document to call attention to important information pertaining to handling, operation, and maintenance of the server; safety and preservation of the equipment, and personal safety:



NOTE: The “note” icon is followed by additional information to be considered.



WARNING: The “warning” icon is followed by information alerting you to a potential situation that may cause damage to property or equipment.



CAUTION: The “caution” icon is followed by information warning you that a situation has the potential to cause bodily harm or death.

SERVICE INFORMATION

The user should not attempt any maintenance or service on the unit beyond the procedures outlined in this document.

Any initial hardware setup problem that cannot be resolved at your internal organization should be referred to an 8e6 Technologies solutions engineer or technical support representative.

8e6 Corporate Headquarters (USA)

Local : 714.282.6111
Domestic US : 1.888.786.7999
International : +1.714.282.6111

8e6 Taiwan

Taipei Local : 2397-0300
Domestic Taiwan : 02-2397-0300
International : 886-2-2397-0300

Procedures

When calling 8e6 Technologies regarding a problem, please provide the representative the following information:

- Your contact information.
- Serial number or original order number.
- Description of the problem.
- Network environment in which the unit is used.
- State of the unit before the problem occurred.
- Frequency and repeatability of the problem.
- Can the product continue to operate with this problem?
- Can you identify anything that may have caused the problem?

PRELIMINARY SETUP PROCEDURES

Unpack the Unit from the Carton

Inspect the packaging container for evidence of mishandling during transit. If the packaging container is damaged, photograph it for reference.

Carefully unpack the unit from the carton and verify that all accessories are included. Save all packing materials in the event that the unit needs to be returned to 8e6 Technologies.

The carton should contain the following items:

- 1 Threat Analysis Reporter unit
- 1 AC Power Cord
- 1 Serial Port Cable
- 1 CAT-5E Crossover Cable
- Rack Mount Brackets (2)
- 1 End User License Agreement (EULA)
- 1 envelope containing a CD-ROM with a PDF of the Threat Analysis Reporter User Guide. The latest version of the user guide can be obtained from our Web site at http://www.8e6.com/docs/tar_ug.pdf.



NOTES: A coupler is included in the carton if a three-foot CAT-5E crossover cable is packaged with your unit instead of a 14-foot CAT-5E crossover cable.

Inspect the server and accessories for damage. If the contents appear damaged, file a damage claim with the carrier immediately.



WARNING: To avoid danger of suffocation, do not leave plastic bags used for packaging the server or any of its components in places where children or infants may play with them.

Select a Site for the Server

The server operates reliably within normal office environmental limits. Select a site that meets the following criteria:

- Clean and relatively free of excess dust.
- Well-ventilated and away from sources of heat, with the ventilating openings on the server kept free of obstructions.
- Away from sources of vibration or physical shock.
- Isolated from strong electromagnetic fields and noise caused by electrical devices such as elevators, copy machines, air conditioners, large fans, large electric motors, radio and TV transmitters, and high-frequency security devices.
- Access space provided so the server power cord can be unplugged from the power supply or the wall outlet—this is the only way to remove the AC power cord from the server.
- Clearance provided for cooling and airflow: Approximately 30 inches (76.2 cm) in the back and 25 inches (63.5 cm) in the front.
- Located near a properly earthed, grounded, power outlet.

Rack Mount the Server

Rack Setup Precautions

 **Warning:**

Before rack mounting the server, the physical environment should be set up to safely accommodate the server. Be sure that:

- The weight of all units in the rack is evenly distributed. Mounting of the equipment in the rack should be such that a hazardous condition is not achieved due to uneven mechanical loading.
- The rack will not tip over when the server is mounted, even when the unit is fully extended from the rack.
- For a single rack installation, stabilizers are attached to the rack.
- For multiple rack installations, racks are coupled together.
- Reliable earthing of rack-mounted equipment is maintained at all times. Particular attention should be given to supply connections other than direct connections to the branch circuit (e.g. use of power strips).
- A power cord will be long enough to fit into the server when properly mounted in the rack and will be able to supply power to the unit.
- The connection of the server to the power supply will not overload any circuits. Consideration should be given to the connection of the equipment to the supply circuit and the effect that overloading of the circuits might have on overcurrent protection and supply wiring. Appropriate consideration of equipment nameplate ratings should be used when addressing this concern.
- The server is only connected to a properly rated supply circuit. Reliable earthing (grounding) of rack-mounted equipment should be maintained.
- The air flow through the server's fan or vents is not restricted. Installation of the equipment in a rack should be such that the amount of air flow required for safe operation of the equipment is not compromised.
- The maximum operating ambient temperature does not exceed 104°F (40°C). If installed in a closed or multi-unit rack assembly, the operating ambient temperature of the rack environment may be greater than room ambient. Therefore, consideration should be given to installing the equipment in an environment compatible with the maximum ambient temperature (T_{ma}) specified by the manufacturer.

 **WARNING:** *Extend only one component at a time. Extending two or more components simultaneously may cause the rack to become unstable*

Rack Mount Instructions

Optional: Install the Chassis Rails

 **NOTE:** If your chassis does not come with chassis rails, please follow the procedure listed on the last page of this sub-section to install the unit directly into the rack.

 **CAUTION:** Please make sure that the chassis covers and chassis rails are installed on the chassis before you install the chassis into the rack. To avoid personal injury and property damage, please carefully follow all the safety steps listed below:

Before installing the chassis rails:

- Close the chassis using the chassis cover.
- Unplug the AC power cord(s).
- Remove all external devices and connectors.

1. Included in the shipping package are a pair of rail assemblies. In each rail assembly, locate the inner rail and the outer rail.
2. Press the locking tab to release the inner rail from its locking position and pull out the inner rail from the rail assembly.

 **NOTE:** The inner rails are to be attached to the chassis and the outer rails are to be installed in the rack.

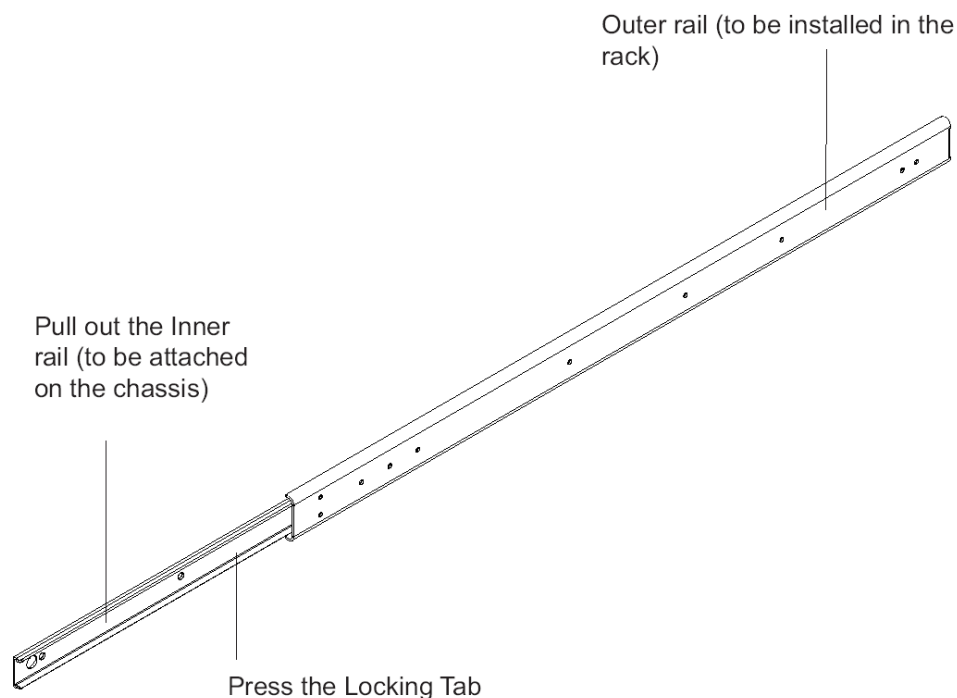

3. Locate the three holes on each side of the chassis and locate the three corresponding holes on each of the inner rail.

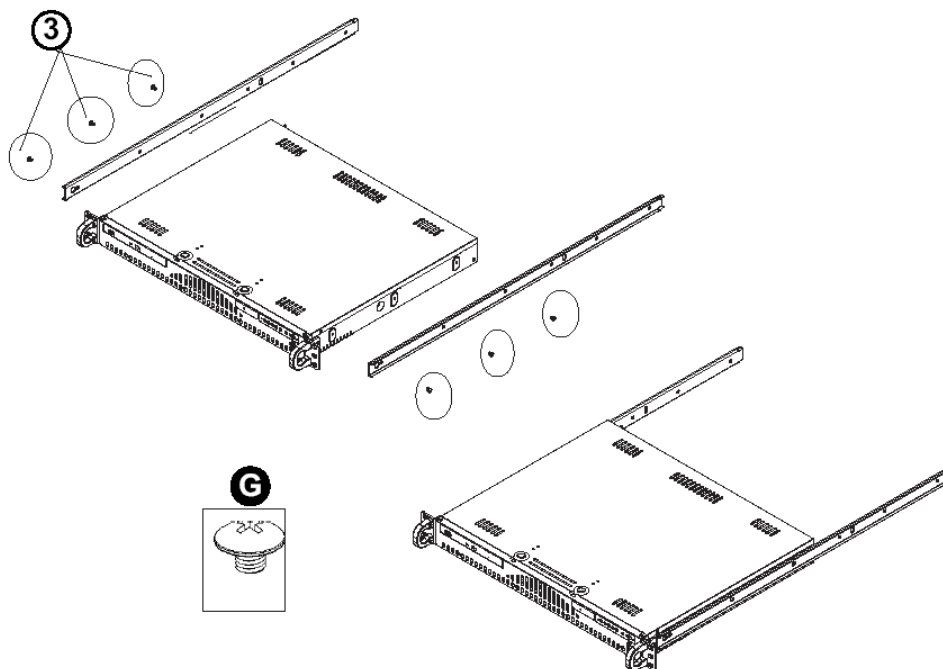

4. Attach an inner rail to each side of the chassis and secure the inner rail to the chassis by inserting three Type G screws through the holes on each side of the chassis and the inner rail. (See the diagram below for a description of the Type G screw.)

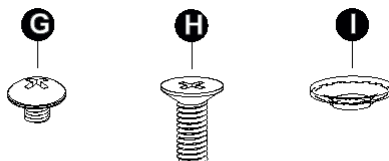

- G. Round head M4 x 4 mm [0.157]
- H. Flat head M5 x 12 mm [0.472]
- I. Washer for M5

5. Repeat the above steps to install the other rail on the chassis.

Optional: Install the Traditional UP Racks

After you have installed the inner rails on the chassis, you are ready to install the outer rails of rail assemblies to the rack.

 **NOTE:** The rails are designed to fit in the racks with the depth of 28" to 33".

- Determine the placement of each component in the rack before you install the rails.
- Install the heaviest server components on the bottom of the rack first, and then work up.

1. In the package, locate a pair of front (short) and rear (long) brackets. Please note that the brackets are marked with Up/Front Arrows (front) and Up/Rear arrows (rear).
2. Secure the front (short) bracket (marked with the Up/Front arrows) to the outer rail with two Type G screws. (See the previous page for a description of the Type G screw.)
3. Attach the rear (long) bracket to the other end of the outer rail and secure the rear (long) bracket to the outer rail with a Type G screw as shown below.
4. Measure the depth of your rack and adjust the length of the rails accordingly.
5. Repeat the same steps to install the other outer rail on the chassis.
6. Secure both outer rail assemblies to the rack with Type H screws and Type I washers. (See the previous page for descriptions of Type H and Type I hardware components.)

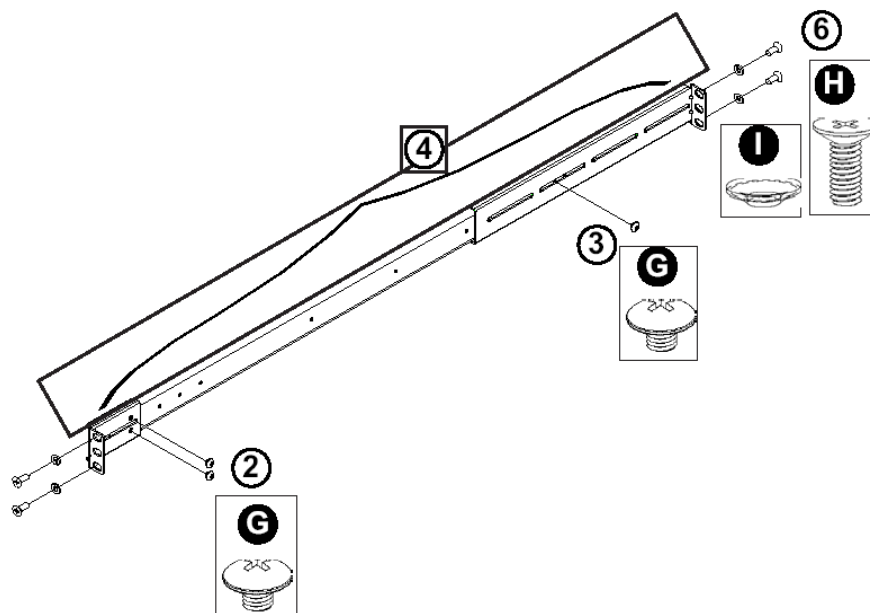

- Slide the chassis into the rack as shown below.

 **NOTE:** The chassis may not slide into the rack smoothly or easily when installed the first time. Some adjustment to the slide assemblies might be needed for easy installation.

- You will need to release the safety taps on both sides of the chassis in order to completely remove the chassis out of the rack.

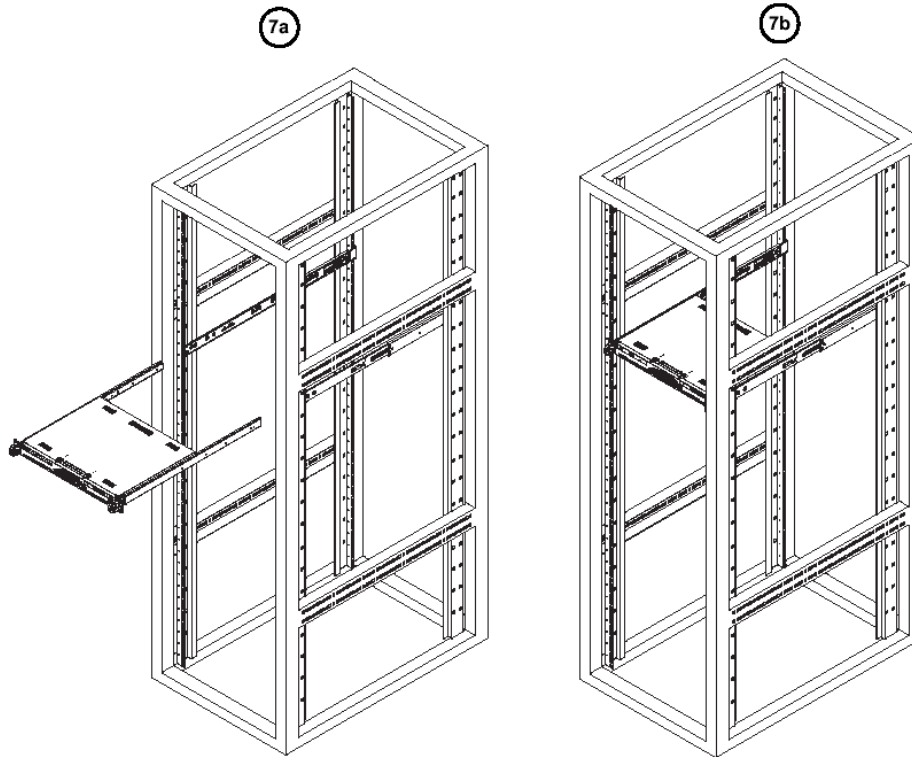

Optional: Install the Open Racks

After you have installed the inner rails on the chassis, you are ready to install the outer rails of rail assemblies to the rack.

 **NOTE:** The rails are designed to fit in the racks with the depth of 28" to 33".

- Determine the placement of each component in the rack before you install the rails.
 - Install the heaviest server components on the bottom of the rack first, and then work up.
1. In the package, locate a pair of front (short) and rear (long) brackets. Please note that the brackets are marked with Up/Front Arrows (front) and Up/Rear arrows (rear).
 2. Secure the front (short) bracket (marked with the Up/Front arrows) to the outer rail with two Type G screws as shown below.

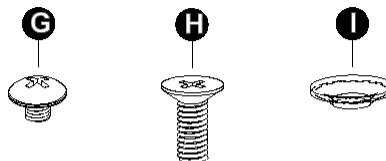
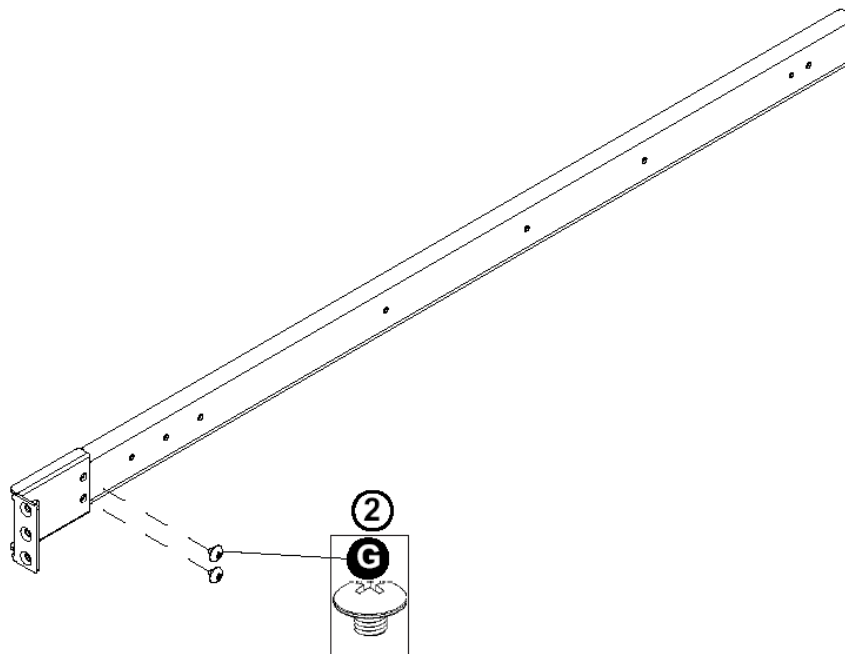

G. Round head M4 x 4 mm [0.157]

H. Flat head M5 x 12 mm [0.472]

I. Washer for M5

3. Attach the front (short) bracket to the front end of the rack, and secure it to the rack with two Type H screws and Type I washers as shown below. (See the previous page for descriptions of Type H and Type I hardware components.)
4. Attach the rear (long) bracket to the rear end of the rack, and secure it to the rack with two Type H screws and Type I washers as shown below. Repeat the same steps to install the other outer rail to the other side of rack.

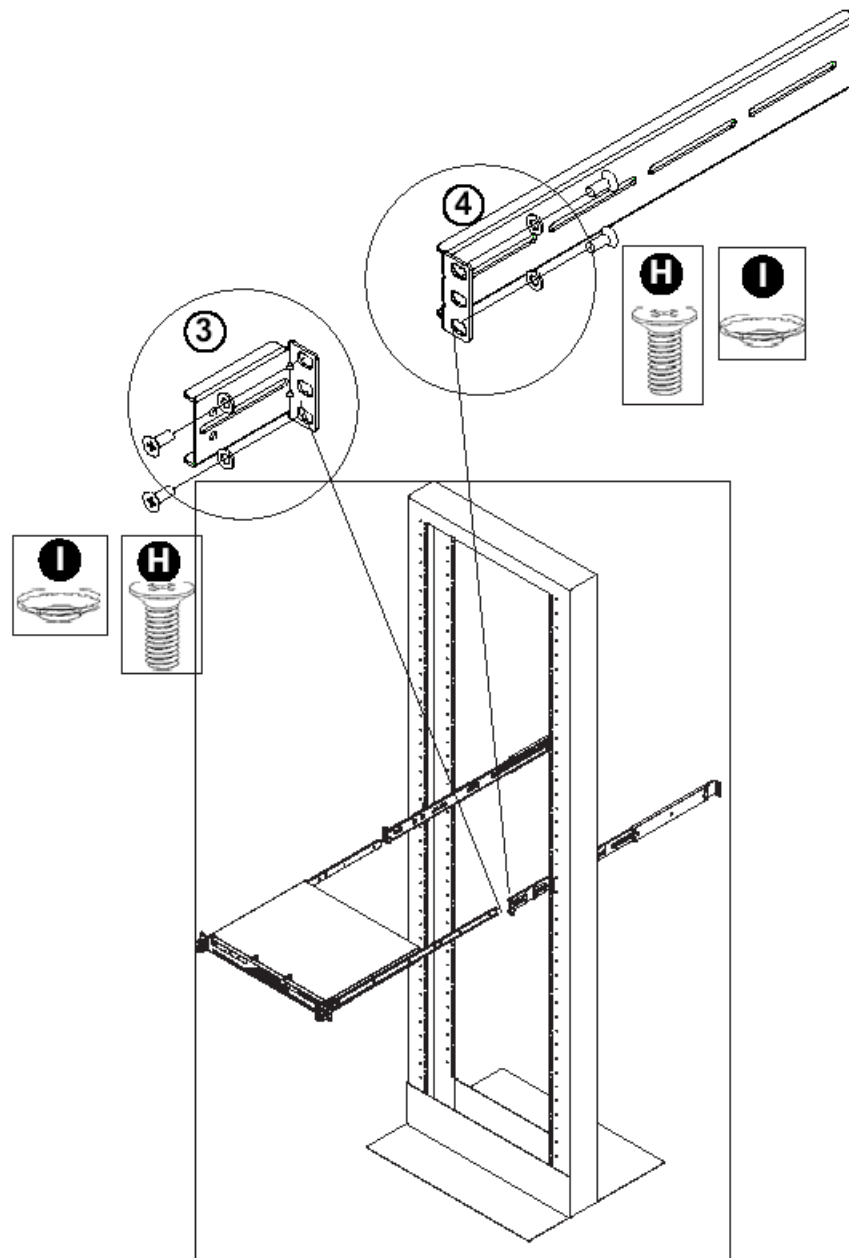

5. Measure the depth of your rack and adjust the length of the rails accordingly. Then, secure the rails to the chassis with Type G screws.

- Slide the inner rails which are attached to the chassis into the outer rails on the rack.

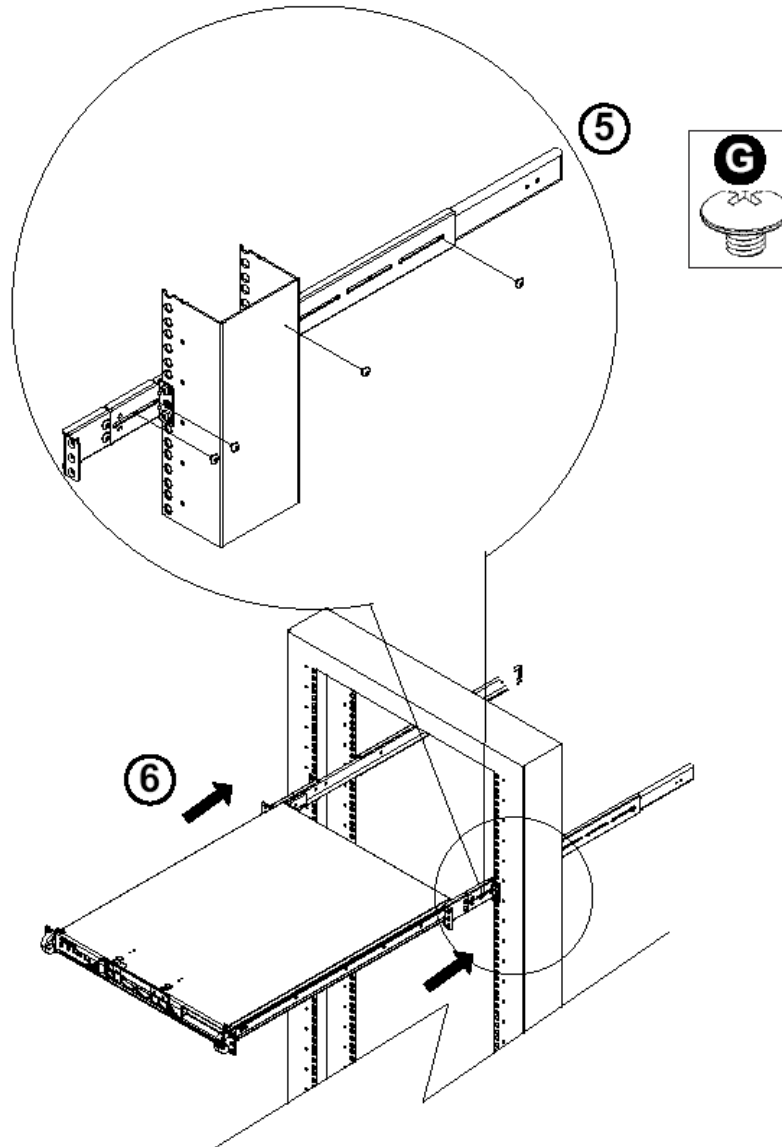

Install the Chassis into the Rack

 **CAUTION:** Before installing the chassis into the rack:

- Make sure that the rack is securely anchored onto an unmovable surface or structure before installing the chassis into the rack.
- Unplug power cord(s) of the rack before installing the chassis into the rack.
- Make sure that the system is adequately supported. Make sure that all the components are securely fastened to the chassis to prevent components falling off from the chassis.
- The rack assembly should be properly grounded to avoid electric shock.
- The rack assembly must provide sufficient airflow to the chassis for proper cooling.
- Please make sure that all components and all chassis covers are properly installed in the chassis before you install the chassis into the racks; otherwise, out-of-warranty damage may occur.

Slide the chassis into the rack and secure it with two screws on each side of the rack as shown in the picture.

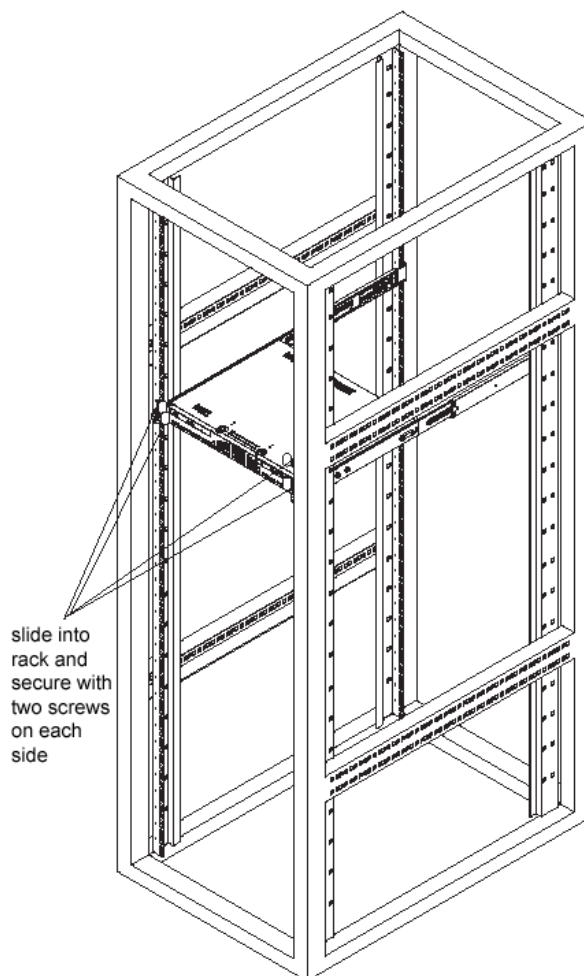

Check the Power Supply

This server is equipped with a universal power supply that handles 100-240 V, 50/60 Hz. A standard power cord interface (IEC 950) facilitates power plugs that are suitable for most European, North American, and Pacific Rim countries.

Power Supply Precautions

 **Warning:**

- Use a regulating uninterruptible power supply (UPS) to protect the server from power surges, voltage spikes and to keep the server operating in case of a power failure.
- In geographic regions that are susceptible to electrical storms, 8e6 highly recommends plugging the AC power cord for the server into a surge suppressor.
- Use appropriately rated extension cords or power strips only.
- Allow power supply units to cool before touching them.

General Safety Information

Server Operation and Maintenance Precautions

Warning:

Observe the following safety precautions during server operation and maintenance:

 **WARNING:** *If the server is used in a manner not specified by the manufacturer, the protection provided by the server may be impaired.*

 **WARNING:** *8e6 Technologies is not responsible for regulatory compliance of any server that has been modified. Altering the server's enclosure in any way other than the installation operations specified in this document may invalidate the server's safety certifications.*

 **CAUTION:** *Never pile books, papers, or other objects on the chassis, drop it, or subject it to pressure in any other way. The internal circuits can be damaged, and the battery may be crushed or punctured. Besides irreparable damage to the unit, the result could be dangerous heat and even fire.*

 **CAUTION:** *There are no user-serviceable components inside the chassis. The chassis should only be opened by qualified service personnel. Never disassemble, tamper with, or attempt to repair the server. Doing so may cause smoke, fire, electrical shock, serious physical injury, or death.*

- Do not insert objects through openings in the chassis. Doing so could result in a short circuit that might cause a fire or an electrical shock.
- Do not operate the server in an explosive atmosphere, in the presence of flammable gases.
- To ensure proper cooling, always operate the server with its covers in place. Do not block any openings on the chassis. Do not place the server near a heater.
- Always exit the software application properly before turning off the server to ensure data integrity.
- Do not expose the server to rain or use near water. If liquids of any kind should leak into the chassis, power down the server, unplug it, and contact 8e6 Technologies technical support.
- Disconnect power from the server before cleaning the unit. Do not use liquid or aerosol cleaners.

AC Power Cord and Cable Precautions

Warning:

- The AC power cord for the server must be plugged into a grounded, power outlet.
- Do not modify or use a supplied AC power cord if it is not the exact type required in the region where the server will be installed and used. Replace the cord with the correct type.
- Route the AC power cord and cables away from moving parts and foot traffic.
- Do not allow anything to rest on the AC power cord and cables.
- Never use the server if the AC power cord has been damaged.
- Always unplug the AC power cord before removing the unit for servicing.

Electrical Safety Precautions

Warning:

Heed the following safety precautions to protect yourself from harm and the server from damage:

 **CAUTION:** *Dangerous voltages associated with the 100-240 V AC power supply are present inside the unit. To avoid injury or electrical shock, do not touch exposed connections or components while the power is on.*

- To prevent damage to the server, read the information in this document for selection of the proper input voltage.
- Do not wear rings or wristwatches when troubleshooting electrical circuits.
- To avoid fire hazard, use only the specified fuse(s) with the correct type number, voltage, and current ratings. Only qualified service personnel should replace fuses.
- Qualified service personnel should be properly grounded when servicing the unit.
- Qualified service personnel should perform a safety check after any service is performed.

Motherboard Battery Precautions



Caution:

The battery on the motherboard should not be replaced without following instructions provided by the manufacturer. Only qualified service personnel should replace batteries.

The battery contains energy and, as with all batteries, a malfunction can cause heat, smoke, or fire, release toxic materials, or cause burns. Do not disassemble, puncture, drop, crush, bend, deform, submerge or modify the battery. Do not incinerate or expose to heat above 140°F (60°C).

There is a danger of explosion if the battery on the motherboard is installed upside down, which will reverse its polarities.

CAUTION: DANGER OF EXPLOSION IF BATTERY IS INCORRECTLY REPLACED. REPLACE ONLY WITH THE SAME OR EQUIVALENT TYPE RECOMMENDED BY THE MANUFACTURER. DISPOSE OF THE USED BATTERIES ACCORDING TO THE MANUFACTURER'S INSTRUCTIONS.

ATTENTION: IL Y A DANGER D'EXPLOSION S'IL Y A REMPLACEMENT INCORRECT DE LA BATTERIE, REMPLACER UNIQUEMENT AVEC UNE BATTERIE DU MÊME TYPE OU D'UN TYPE ÉQUIVALENT RECOMMANDÉ PAR LE CONSTRUCTEUR. METTRE AU REBUT LES BATTERIES USAGÉES CONFORMÈMENT AUX INSTRUCTIONS DU FABRICANT.

INSTALL THE SERVER

Step 1: Initial Setup Procedures

This step requires you to link the workstation to the Threat Analysis Reporter. You have the option of using the text-based step-by-step setup procedures described in Step 1A.

Step-by-Step Setup Requirements

- Threat Analysis Reporter unit with AC power cord
- either one of two options:
 - PC monitor with AC power cord and keyboard, or
 - PC laptop computer with HyperTerminal and serial port cable (and USB DB9 serial adapter, if there is no serial port on your laptop)



NOTE: Before installing the Threat Analysis Reporter server, the R3000 server to be used with this server must already be installed and running software version 2.0.10 or higher.

Go to Step 1A to execute Step-by-Step Setup Procedures.

Step 1A: Step-by-Step Setup Procedures

Link the Workstation to the Threat Analysis Reporter

Monitor and Keyboard Setup

- A. Connect the PC monitor and keyboard cables to the rear of the chassis (see Fig. 1).
- B. Turn on the PC monitor.
- C. Power on the Threat Analysis Reporter by dropping down the face plate and pressing the large button at the right of the front panel (see Fig. 2).

Once the Threat Analysis Reporter is powered up, proceed to the Step-by-Step Initial Setup Procedures instructions.

Serial Console Setup

- A. Using the serial port cable (and USB DB9 serial adapter, if necessary), connect the laptop to the rear of the chassis (see Fig. 1).
- B. Power on the laptop.
- C. Power on the Threat Analysis Reporter by pressing the large button on the front panel (see Fig. 2).



Fig. 1 - Portion of chassis rear

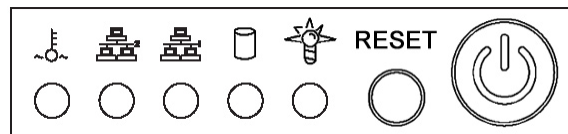

Fig. 2 - Diagram of chassis front panel, power button at far right

Once the Threat Analysis Reporter is powered up, proceed to the instructions for Hyper-Terminal Setup Procedures.

HyperTerminal Setup Procedures

If using a serial console, follow these procedures to create a HyperTerminal session on the serial console.

- A. Launch HyperTerminal by going to Start > Programs > Accessories > Communications > HyperTerminal:



- B. In the Connection Description dialog box, enter any session **Name**, and then click **OK** to open the Connect To dialog box:



- C. At the **Connect using** field, select the COM port assigned to the serial port on the laptop (probably “COM1”), and then click **OK** to open the Properties dialog box, displaying the Port Settings tab:

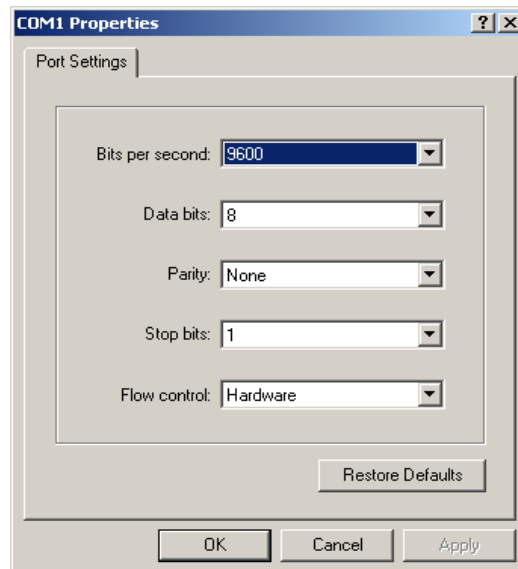

- D. Specify the following session settings:

- Bits per second: 9600
- Data bits: 8
- Parity: None
- Stop bits: 1
- Flow control: Hardware

- E. Click **OK** to connect to the HyperTerminal session:

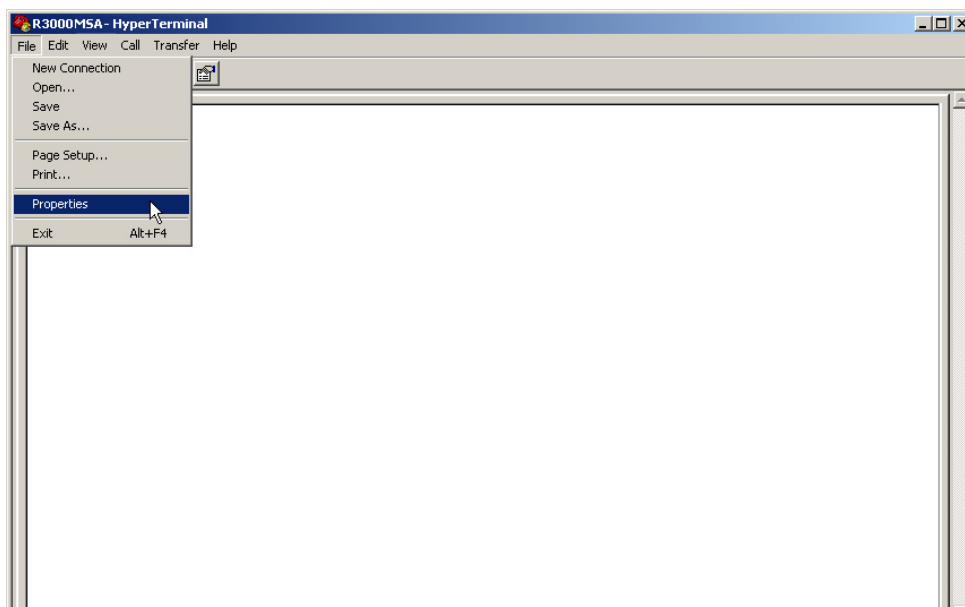

- F. In the HyperTerminal session window, go to File > Properties to open the Properties dialog box, displaying the Connect To and Settings tabs:

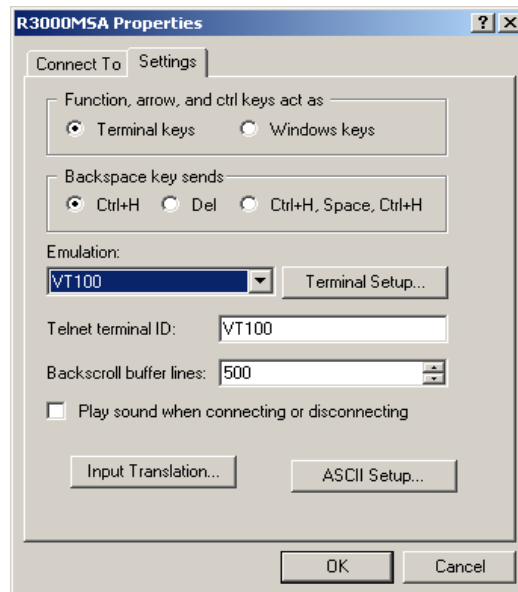

- G. Click the Settings tab, and at the **Emulation** menu select "VT100".
- H. Click **OK** to close the dialog box, and to go to the login screen.

 **NOTE:** If using a HyperTerminal session, the login screen will display with black text on a white background.

Step-by-Step Initial Setup Procedures

For these step-by-step setup procedures, you will need your network administrator to provide you the LAN 1 and LAN 2 IP address and subnet mask, gateway IP address, DNS server IP address(es), host name of the server, and IP address for the Web interface (if using a NAT device).

Login screen, password prompts

The login screen displays after powering on the Threat Analysis Reporter unit using a monitor and keyboard, or after creating a HyperTerminal session.



NOTE: If the screensaver currently displays on your screen, press the **Enter** key to display the login screen.

- A. At the **login** prompt, type in *menu*.
- B. Press the **Enter** key to display the Password prompt.
- C. At the **Password** prompt, type in the following: *#s3tup#r3k*
- D. Press **Enter** to display the System Configuration screen:

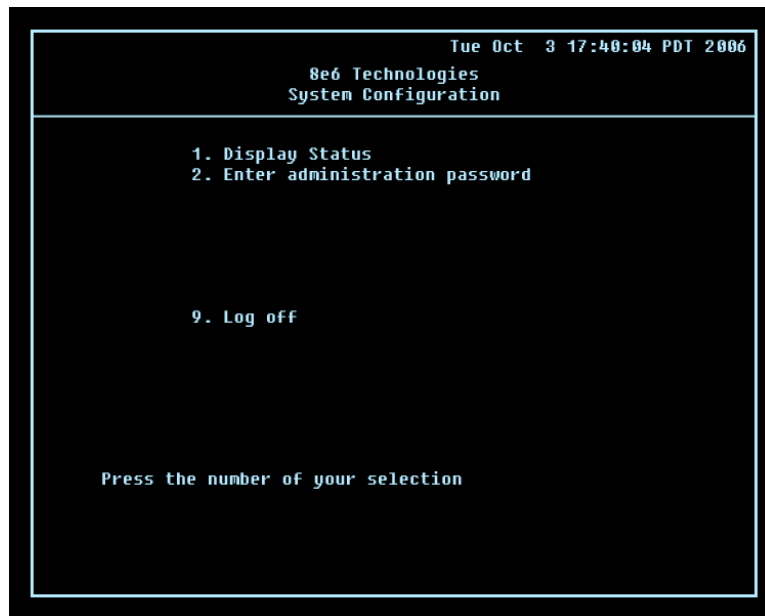

- E. At the **Press the number of your selection** prompt, press **2** to display the Administrator Password Entry screen:

```
Tue Oct 3 17:40:10 PDT 2006
8e6 Technologies
Administrator Password Entry

Enter the administrator password:

Press ESCAPE to cancel
```

- F. At the **Enter the administrator password** prompt, re-enter your password:
#s3tup#r3k
- G. Press **Enter** to display the Administration menu where you can begin the step-by-step initial setup process using the configuration screens:

```
Tue Oct 3 17:40:04 PDT 2006
8e6 Technologies
System Configuration -- Administration menu

1. Display Status
2. Initial Setup step-by-step
3. Configure network interface LAN1
4. Configure network interface LAN2
5. Configure default gateway
6. Configure DNS servers
7. Configure host name
8. Time Zone regional setting
9. Web interface IP address
A. Configure setup wizard user
B. Reboot system
C. Change administration password
X. Exit administration menu

Press the number of your selection
```

- H. At the **Press the number of your selection** prompt, press **2** to select the “Initial Setup step-by-step” process. This process takes you to the Configure Network Interface screen.

Configure Network Interface screen

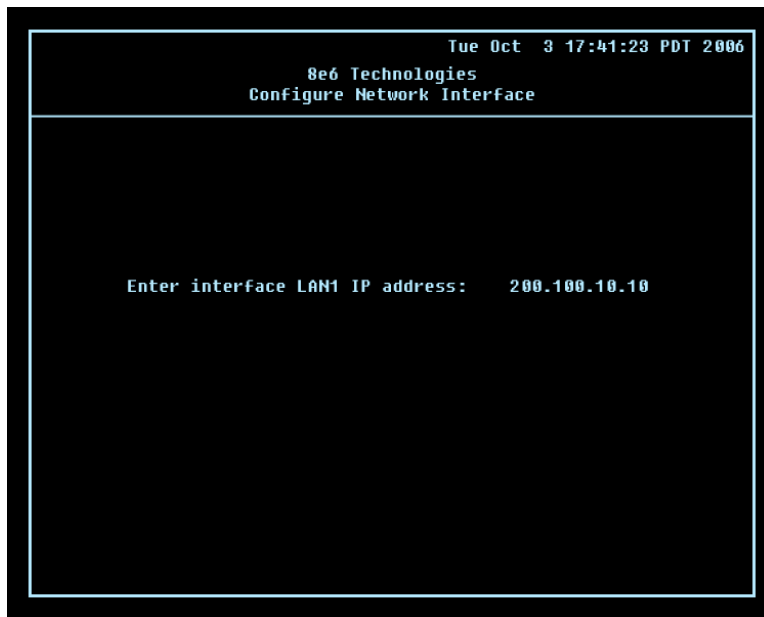

- A. At the **Enter interface LAN1 (eth0) IP address** field, enter the IP address for the LAN 1 (Ethernet 0) interface, and then press **Enter** to go to the next screen.

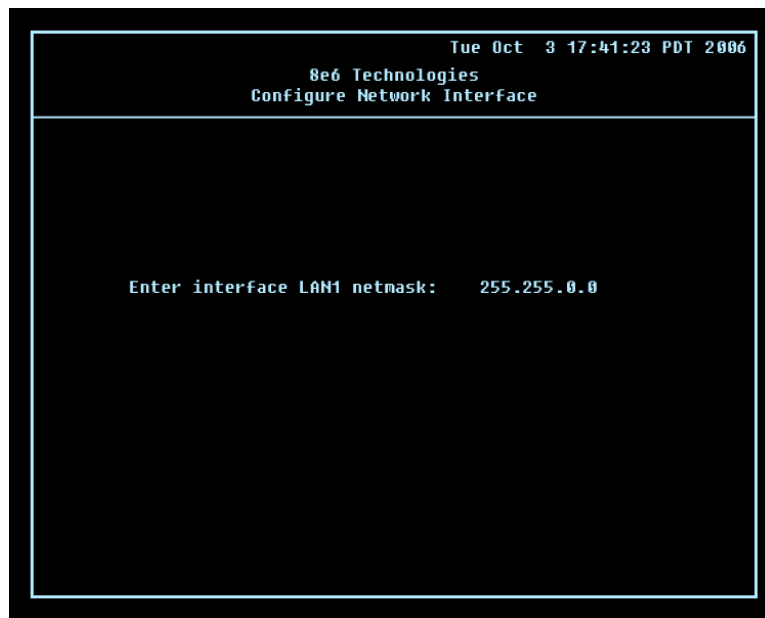

- B. At the **Enter interface LAN1 (eth0) netmask** field, enter the subnet mask for the LAN 1 (Ethernet 0) interface using the dotted decimals notation format. Press **Enter** to display the confirmation prompt.

- C. Press **Y** for “Yes” to confirm and save your entries for the LAN1 (eth0) interface, and to go to the next screen.

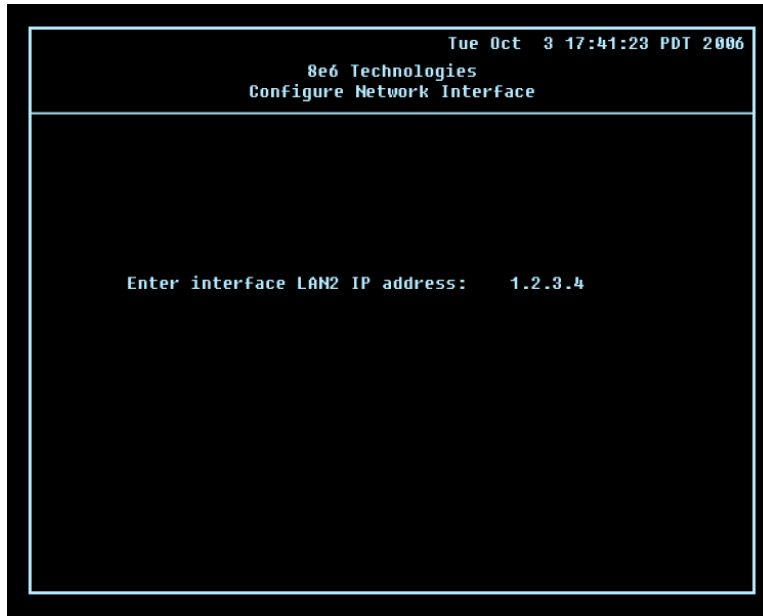

- D. At the **Enter interface LAN2 (eth1) IP address** field, enter the IP address for the LAN 2 (Ethernet 1) interface, and then press **Enter** to go to the next screen.

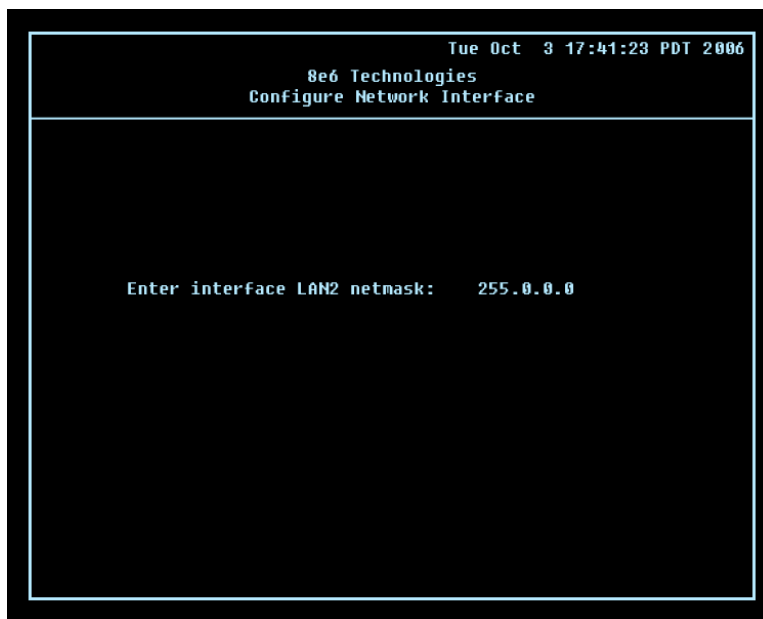

- E. At the **Enter interface LAN2 (eth1) netmask** field, using the dotted decimals notation format, enter the subnet mask for the LAN 2 (Ethernet 1) interface. Press **Enter** to display the confirmation prompt.
- F. Press **Y** for “Yes” to confirm and save your entries for the eth1 interface, and to go to the Configure default gateway screen.

Configure default gateway screen



- A. At the **Enter default gateway IP** field, enter the IP address for the default gateway. Press **Enter** to display the confirmation prompt.
- B. Press **Y** for “Yes” to confirm and save your entry for the gateway IP address, and to go to the Configure Domain Name Servers screen.

Configure Domain Name Servers screen

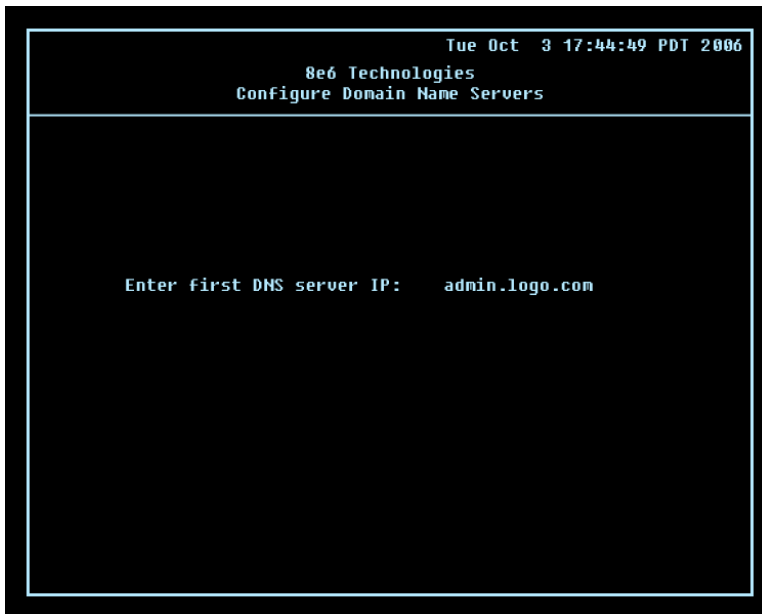

- A. At the **Enter first DNS server IP** field, enter the IP address for the primary Domain Name Server. Press **Enter** to go to the next screen.

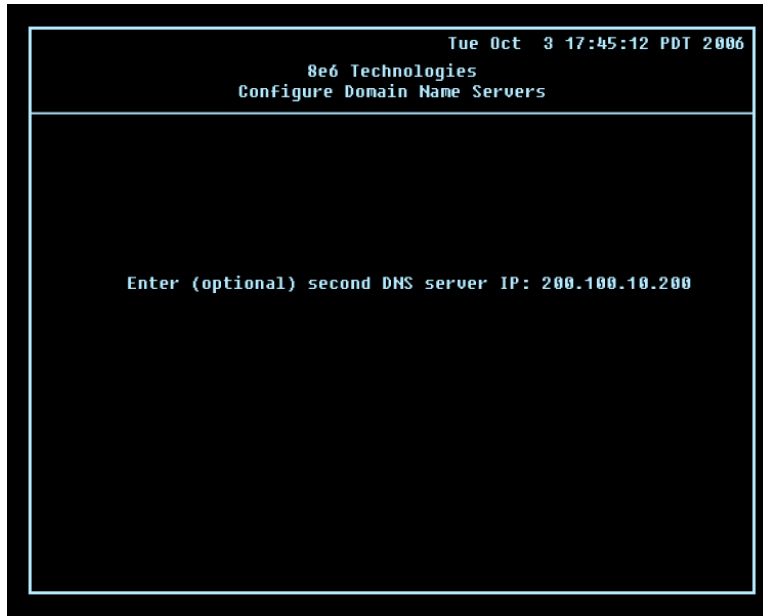

- B. At the **Enter (optional) second DNS server IP** field, if you have a secondary Domain Name Server you wish to use, enter the IP address for that server. Press **Enter** to display the confirmation prompt.
- C. Press **Y** for “Yes” to confirm and save your entries for the domain name servers, and to go to the Configure Host Name screen.

Configure Host Name screen

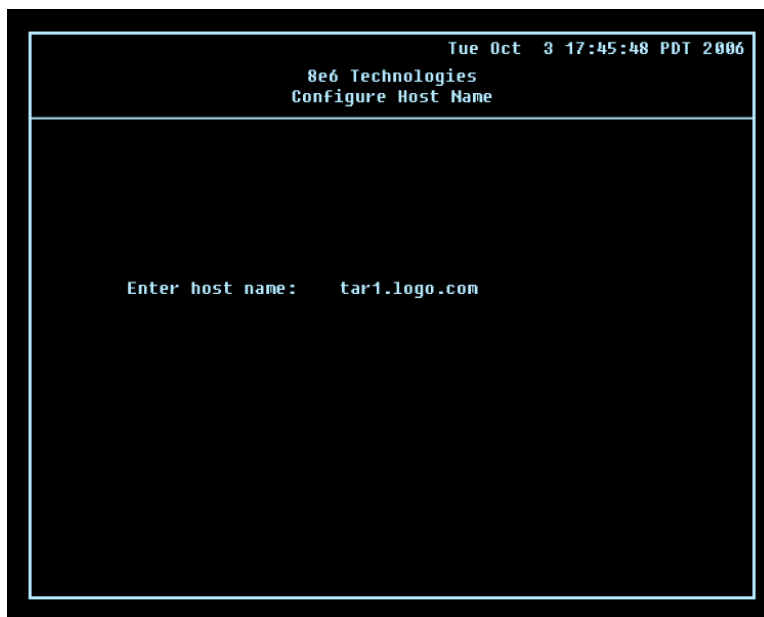

- A. At the **Enter host name** field, enter the host name of the server. Press **Enter** to display the confirmation prompt.
- B. Press **Y** for “Yes” to confirm and save your entry for the host name, and to go to the Time zone regional configuration screen.

Time zone regional configuration screen



- A. Use the up and down arrows in your keyboard to select your region. After selecting your locality, press **Y** for “Yes” to confirm and save your regional selection, and to go to the next screen:



- B. Use the up and down arrows in your keyboard to select your region. After selecting your locality, press **Y** for “Yes” to confirm and save your regional selection, and to go to the Configure Wizard user screen.

Configure Wizard user screen



- A. At the **Enter wizard user name** field, enter the username that will be used to access the setup wizard in the Threat Analysis Reporter interface. Press **Enter** to display the confirmation prompt.
- B. Press **Y** for “Yes” to confirm and save your entry and to go to the next screen.

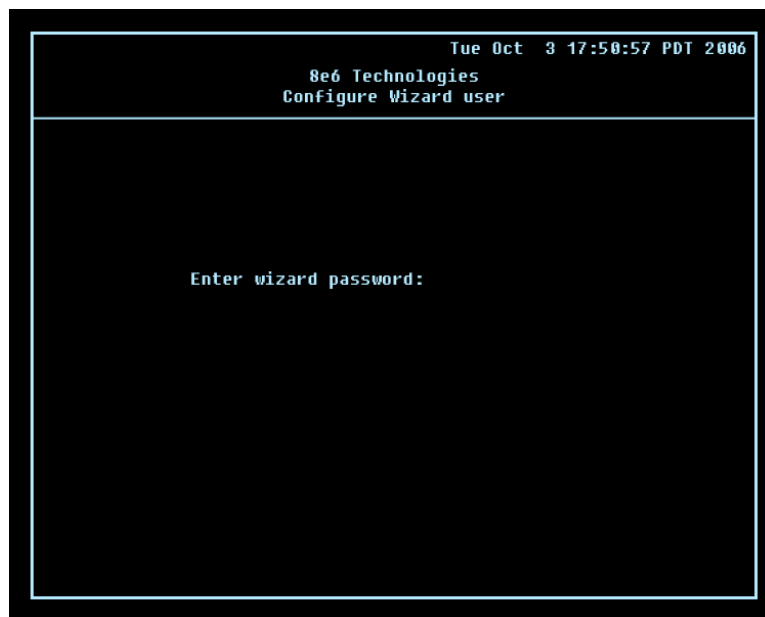

- C. At the **Enter wizard password** field, enter the password that will be used to access the setup wizard in the Threat Analysis Reporter interface. Press **Y** for “Yes” to confirm and save your entry and to go to the Setup Wizard Confirmation screen.

Setup Wizard Confirmation screen

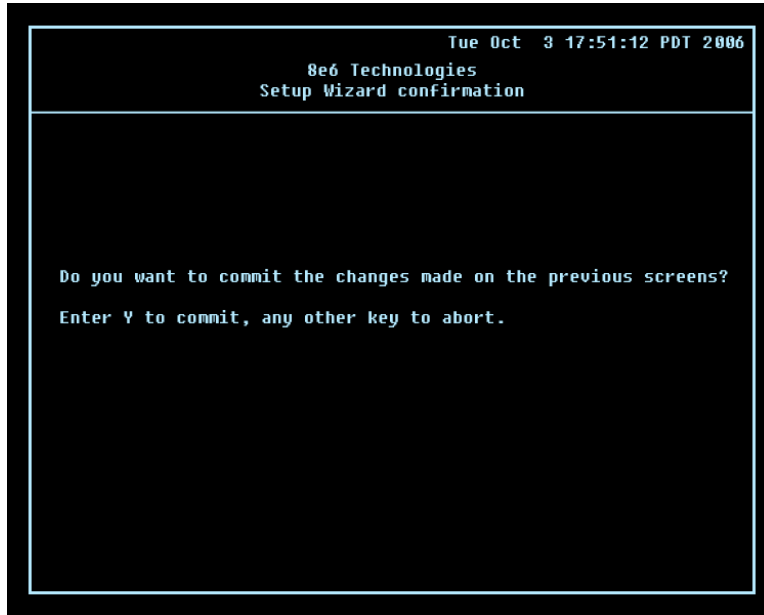

Press **Y** for “Yes” to save all your wizard entries and to return to the Administration menu.



NOTE: When saving your entries, there may be a 4-10 second delay before the Administration menu displays.

Administration menu

After making all entries using the step-by-step initial setup process, you will return to the Administration menu. Press **X** to return to the System Configuration screen. Or, to verify the status of the Threat Analysis Reporter and review the entries you made using the wizard, press **1** to view the System Status screen.



NOTE: Changing your password using option C, “Change administration password”, will change the password for the console menu but not the Threat Analysis Reporter console login screen.

System Status Screen

```

Tue Oct 3 17:40:04 PDT 2006
8e6 Technologies
System Status - updates every 10 seconds

LAN1 interface for web access and R3000 communications
LAN1 IP = 200.100.10.10 Mask = 255.255.0.0           Active
LAN2 interface for bandwidth monitoring
LAN2 IP = 1.2.3.4 Mask = 255.0.0.0               Inactive
Default gateway IP: 200.100.10.1
TAR host name: tar1.logo.com

DNS server IP address(es): admin.logo.com 200.100.10.200

TAR processing is normal
Current Version: Threat Analysis Reporter 1.0.10.8

Press any key to return to menu...

```

The System Status screen contains the following information:

- **LAN1 (eth0) interface for web access and R3000 communications:** LAN1 (eth0) IP address and netmask specified in screen 3 (Configure Network Interface), and current status (“Active” or “Inactive”)
- **LAN2 (eth1) interface for bandwidth monitoring:** LAN2 (eth1) IP address and netmask specified in screen 4 (Configure Network Interface), and current status (“Active” or “Inactive”)
- **Default gateway IP** address specified in screen 5 (Configure default gateway)
- **Configure host name** specified in screen 7 (Configure Host Name)
- **DNS server IP address(es)** specified in screen 6 (Configure Domain Name Servers)
- Current status of the Threat Analysis Reporter
- Current Version of the Threat Analysis Reporter software



NOTE: Modifications can be made at any time by returning to the specific screen of the wizard.

Log Off, Disconnect the Peripherals

- After completing the wizard setup procedures, return to the System Configuration screen and press **9** to log out.
- Disconnect the peripherals from the Threat Analysis Reporter.
- Proceed to Physically Connect the Unit to the Network.

Physically Connect the Unit to the Network

After performing initial setup procedures for the Threat Analysis Reporter, the unit should be physically connected to the network. This step requires a standard CAT-5E cable to connect the unit to the network. An additional CAT-5E cable is required if the Ethernet Tap unit will be installed for bandwidth monitoring.

- A. Plug one end of a standard CAT-5E cable into the Threat Analysis Reporter's LAN 1 port, the port on the left.



Portion of chassis rear

- B. Plug the other end of the CAT-5E cable into an open port on the network switch.

Bandwidth Management

If you choose to install the Ethernet Tap for bandwidth monitoring, you will need to connect it to the Threat Analysis Reporter at this point. Refer to Appendix A at the end of this document for instructions on how to connect the Ethernet Tap unit.

Step 2: Wizard Setup Procedures

For this step, you will need your network administrator to provide you the following information:

- IP range and netmask of machines on the network the Threat Analysis Reporter server will be monitoring
- R3000 IP address, port number to be used between the R3000 and Threat Analysis Reporter, and type of authentication method to be used (IP group or LDAP)
- 8e6 Enterprise Reporter server IP address and server name, if an ER unit is connected to the R3000

Access the Threat Analysis Reporter Administrator Console

- Launch Internet Explorer.
- In the address field, type in **http://x.x.x.x:8080/8e6tar/wizard.html** (in which “x.x.x.x” represents the eth0 IP address entered in the Connect Network Interface screen of the Step-by-Step Initial Setup Procedures). In our example, this entry would be: **http://200.100.10.10:8080/8e6tar/wizard.html**.
- Click **Go** to open the Threat Analysis Reporter interface and the EULA Agreement dialog box:

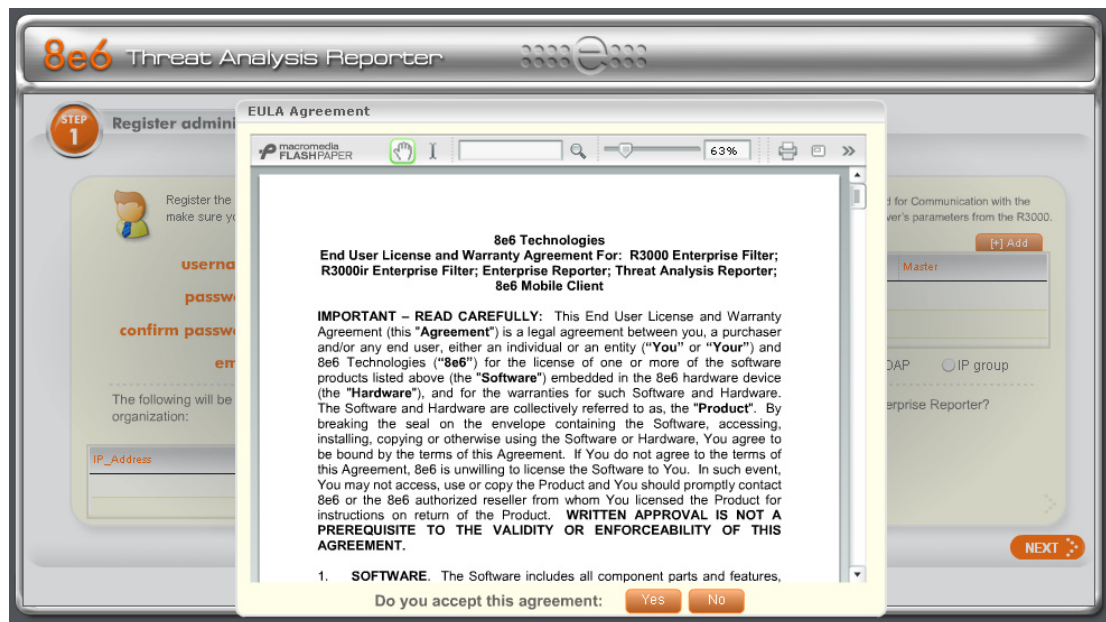

- D. After reading the End User License Agreement, you have the option to do either of the following:
- Click **No** to close both the EULA Agreement dialog box and the Threat Analysis Reporter interface. You will not be able to enable the Threat Analysis Reporter for use in your environment.
 - Click **Yes** to close the EULA Agreement dialog box and to open the Login dialog box:



Proceed to the next sub-section: Log in to the Threat Analysis Reporter Administrator Console.

Log in to the Threat Analysis Reporter Administrator Console

- In the **Username** field of the Login dialog box, type in the username specified in the Configure Wizard user screen of the Step-by-Step Initial Setup Procedures. In our example, this entry would be: **taruser**.
- In the **Password** field, type in the password specified in the Configure Wizard user screen of the Step-by-Step Initial Setup Procedures.
- Click **LOGIN** to close the login dialog box and to go to Step 1 of wizard setup procedures in the Threat Analysis Reporter Administrator console (see Step 1: Register administrator).

Step 1: Register administrator

Step 1 is performed in the left side of the first screen of the wizard:

The screenshot displays the '8e6 Threat Analysis Reporter' wizard interface. It is divided into two main sections: 'STEP 1 Register administrator' and 'STEP 2 Register R3000 & ER'.
 In the 'STEP 1' section, there is a form for registering the first administrator. The fields are:

- username :** jsmith23
- password :** masked with asterisks
- confirm password :** masked with asterisks
- email :** jsmith23@logo.com

 Below the form, there is a table for organization IP ranges with columns 'IP_Address' and 'Netmask', and an '+ Add' button.
 In the 'STEP 2' section, there is a table for R3000 servers with columns 'IP_Address', 'Server_Name', and 'Master', and an '+ Add' button. Below the table, there are radio buttons for 'Authentication Type' (LDAP and IP group) and a question 'ER // Do you have an Enterprise Reporter?' with 'Yes' and 'No' radio buttons. A 'NEXT' button is located at the bottom right of the wizard.
 At the bottom of the wizard, a progress bar shows 'Completed Steps' 1 through 4, with step 1 highlighted.

- Enter the **username** the global administrator will use when logging into the Threat Analysis Reporter Administrator console. The global administrator has the highest level of permissions in the Threat Analysis Reporter interface.
- Enter the **password** to be used with that username, and enter the same password again in the **confirm password** field.
- Enter the **email** address of the global administrator, who will be notified via email when gauges reach their specified upper threshold limits.

D. Click the [+] Add tab below to open the IP Range Information dialog box:



E. Enter the **IP address** range for the bandwidth the Threat Analysis Reporter will monitor.

F. Enter the **Netmask** for the IP range to be monitored, using the dotted decimals notation format.

G. Click **OK** to close the dialog box and to display your entries in the list box:

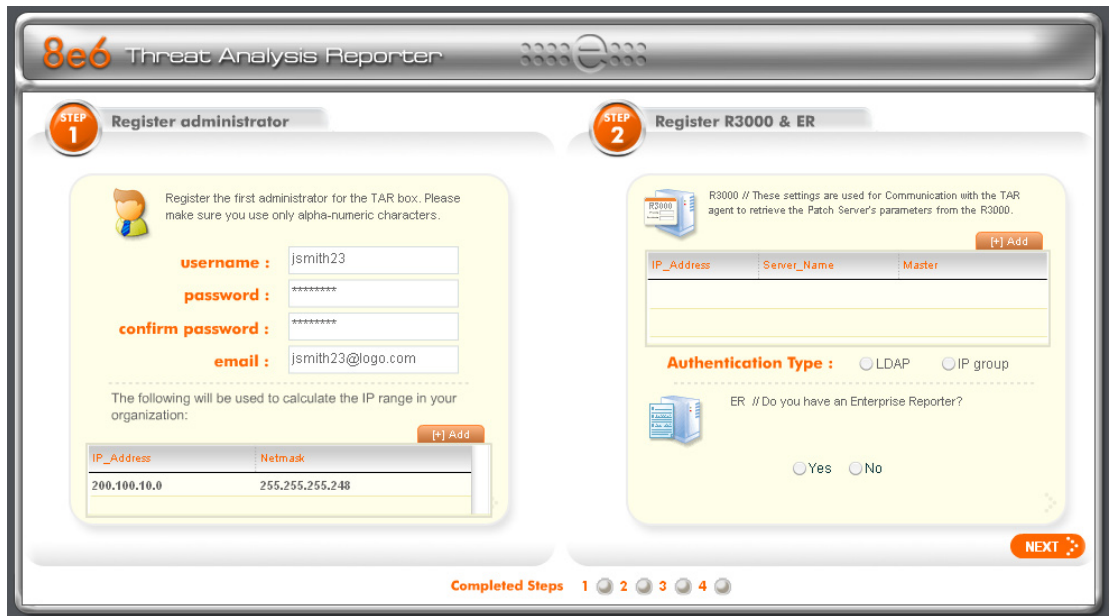

NOTE: Additional IP address ranges can be included by clicking the [+] Add tab again and making the entries described in steps E through G above.

To modify an IP address range, double-click the entry in the list box to highlight it and to display the [-] Remove tab to the left of the [+] Add tab:

8e6 Threat Analysis Reporter

STEP 1 Register administrator

Register the first administrator for the TAR box. Please make sure you use only alpha-numeric characters.

username : jsmith23

password : *****

confirm password : *****

email : jsmith23@logo.com

The following will be used to calculate the IP range in your organization:

IP_Address	Netmask
200.100.10.0	255.255.255.248
200.100.10.10	255.255.255.248

[+] Add [-] Remove

STEP 2 Register R3000 & ER

R3000 // These settings are used for Communication with the TAR agent to retrieve the Patch Server's parameters from the R3000.

IP_Address	Server_Name	Master

Authentication Type : LDAP IP group

ER // Do you have an Enterprise Reporter?

Yes No

NEXT

Completed Steps 1 2 3 4

- To modify the entries made for the IP address range, click the [+] Add tab to re-open the IP Range Information dialog box and edit information, as necessary. Click **OK** to close the dialog box and to display the modified information in the list box.
- To remove the entry for the IP address range from the list box, click the [-] Remove tab. Click the [+] Add tab to open the IP Range Information dialog box and make new entries for the IP address range.

Step 2: Register R3000 & ER

Step 2 is performed in the right side of the first screen of the wizard.

R3000:

Specify information for the R3000 to be used with the Threat Analysis Reporter:

- A. Click the [+] Add tab above the R3000 list box to open the R3000 Information dialog box:



- B. Enter the **IP address** of the R3000 server to be used with the Threat Analysis Reporter. In our example, this is: **200.100.160.74**, which is the Ethernet 1 IP address of the R3000 server.
- C. Enter the **Server Name** of the R3000 to be used with the Threat Analysis Reporter, which is any name you wish to associate with that R3000. In our example, this is: **R3000LOGO**.
- D. Respond to the question “Is this your Master R3000?” by clicking the “Yes” checkbox, if this R3000 will be designated the master R3000 to be associated with the Threat Analysis Reporter. Otherwise, leave the checkbox blank.

E. Click **OK** to close the dialog box and to display your entries in the list box:

The screenshot shows the 8e6 Threat Analysis Reporter interface. It is divided into two main sections: Step 1 and Step 2.

STEP 1: Register administrator

Register the first administrator for the TAR box. Please make sure you use only alpha-numeric characters.

username : jsmith23
 password : *****
 confirm password : *****
 email : jsmith23@logo.com

The following will be used to calculate the IP range in your organization:

IP_Address	Netmask
200.100.10.10	255.255.255.248

[+] Add

STEP 2: Register R3000 & ER

R3000 // These settings are used for Communication with the TAR agent to retrieve the Patch Server's parameters from the R3000.

IP_Address	Server_Name	Master
200.100.160.74	R3000LOGO	Master

Authentication Type : LDAP IP group

ER // Do you have an Enterprise Reporter?
 Yes No

NEXT

Completed Steps 1 2 3 4

 **NOTE:** Additional R3000 servers can be included by clicking the [+] Add tab again and making the entries described in steps A through E above.

To modify an R3000 entry, double-click the R3000 entry in the list box to highlight it and to display the Set as Master tab and the [-] Remove tab to the left of the [+] Add tab:

The screenshot shows the 8e6 Threat Analysis Reporter interface, similar to the previous one, but with a second R3000 entry highlighted in the list box.

STEP 2: Register R3000 & ER

R3000 // These settings are used for Communication with the TAR agent to retrieve the Patch Server's parameters from the R3000.

IP_Address	Server_Name	Master
200.100.160.74	R3000LOGO	Master
200.100.160.77	R3000LOGO2	

Set as Master [-] Remove [+] Add

Authentication Type : LDAP IP group

ER // Do you have an Enterprise Reporter?
 Yes No

NEXT

Completed Steps 1 2 3 4

- To modify the IP address and Server Name for the R3000 server, click the [+] Add tab to re-open the R3000 Information dialog box, and edit information as necessary. Click **OK** to close the dialog box and to display the modified information in the list box.
 - To designate an R3000 as the Master R3000 server, click the entry for the R3000 server in the list box to highlight it, and then click the Set as Master tab to display “Master” in the Master column for that entry in the list box.
 - To remove the entry for the R3000 server from the list box, click the [-] Remove tab.
- F. Specify the **User Authentication method** to be used for monitoring activity on the Threat Analysis Reporter server: “LDAP” or “IP group”:

The screenshot shows the 8e6 Threat Analysis Reporter installation wizard. It is divided into two main sections: Step 1 and Step 2.

STEP 1: Register administrator

Register the first administrator for the TAR box. Please make sure you use only alpha-numeric characters.

username : jsmith23
password : *****
confirm password : *****
email : jsmith23@logo.com

The following will be used to calculate the IP range in your organization:

IP_Address	Netmask
200.100.10.10	255.255.255.248

[+] Add

STEP 2: Register R3000 & ER

R3000 // These settings are used for Communication with the TAR agent to retrieve the Patch Server's parameters from the R3000.

IP_Address	Server_Name	Master
200.100.160.74	R3000LOGO	Master

[+] Add

Authentication Type : LDAP IP group

ER // Do you have an Enterprise Reporter?

Yes No

NEXT

Completed Steps 1 2 3 4

ER:

Respond to the question “Do you have an Enterprise Reporter?” by clicking the radio button corresponding to either “Yes” or “No”.

- If “No” was selected, click **NEXT >** at the bottom right of the screen to go to Step 3.
- If “Yes” was selected, the IP address and Server Name fields display in place of the radio buttons. The < Back button displays above the Server Name field.

 **NOTE:** To change your answer from “Yes” to “No,” click the < **Back** button to re-display the question “Do you have an Enterprise Reporter?”

- Enter the **IP address** of the ER server to be used with the Threat Analysis Reporter. In our example, this is: **200.10.101.76**.
- Enter the **Server Name** of the ER server to be used with the Threat Analysis Reporter. In our example, this is: **er4logo**.
- Click **NEXT >** at the bottom right of the screen to go to Step 3.

 **NOTE:** Upon clicking **NEXT >** the wizard will verify whether the settings made in Step 1 and Step 2 are correct. If there is an error in any entry made, an orange asterisk flashes beside the field in which the error was made. Correct the error and click **NEXT >** again to go to Step 3.

Step 3: Register Gauges

Step 3 requires you to specify settings for default gauges to be monitored by the Threat Analysis Reporter. These gauges will display in the Threat Analysis Reporter interface upon logging into the Administrator console.

8e6 Threat Analysis Reporter

STEP 3 Register Gauges

Please select your default gauges from the list below. (You can always go back and change this selection).

Gauge Groups:

Selected	Gauges
<input checked="" type="checkbox"/>	Adult Content
<input checked="" type="checkbox"/>	Security
<input checked="" type="checkbox"/>	Shopping
<input checked="" type="checkbox"/>	Bandwidth
<input checked="" type="checkbox"/>	Illegal

Please make any changes to the selected gauge group. You can also select a sub gauge group from the next table.

Gauge Components :

Selected	Name	Lower Limit	Higher Limit
	<input type="text"/>	<input type="text"/>	<input type="text"/>
	<input type="text"/>	<input type="text"/>	<input type="text"/>
	<input type="text"/>	<input type="text"/>	<input type="text"/>
	<input type="text"/>	<input type="text"/>	<input type="text"/>
	<input type="text"/>	<input type="text"/>	<input type="text"/>

Completed Steps 1 2 3 4

 **NOTE:** Return to Step 1 or Step 2 by clicking the < **BACK** button in the lower left corner of this wizard screen.

Specify Gauge Groups to be Monitored

By default, all Gauges displayed in this wizard screen (Adult Content, Security, Shopping, Bandwidth, Illegal) are selected for monitoring. To deselect a gauge from the Gauge Groups list, remove the checkmark by clicking the checkbox in the Selected column corresponding to that gauge.

View, Edit Gauge Components

To view gauge components for a specified gauge, highlight and double-click the gauge name to populate the the fields to the right of the Gauge Groups list box.

The screenshot shows the '8e6 Threat Analysis Reporter' interface at 'STEP 3 Register Gauges'. It features a 'Gauge Groups' list on the left with 'Adult Content' selected. The 'Gauge Components' table on the right lists components like 'Explicit_Art', 'Pornography/Adult Conten', 'Child Pornography', 'Obscene/Tasteless', and 'R_Rated', all of which are checked. Below the table are input fields for 'Name' (Adult Content), 'Lower Limit' (0), and 'Higher Limit' (200). Navigation buttons for 'BACK' and 'NEXT' are at the bottom, along with a progress indicator showing 3 completed steps.

The following gauge criteria can be edited:

- **Name:** The displayed gauge name to be used in the interface can be modified by making an entry in this field.
- **Lower Limit:** The default amount (“0” or zero) that will represent the lower end of the gauge can be adjusted to accommodate the type of activity to be monitored on your network.
- **Higher Limit:** The default amount (“200”) that will represent the higher end of the gauge can be adjusted to accommodate the type of activity to be monitored on your network.
- **Gauge Components:** To remove a gauge component, go to the Selected column and click the checkmark in the checkbox corresponding to the component to be removed.



NOTE: The settings saved in this step can be modified later in the interface.

Click **NEXT >** at the bottom right of the screen to go to Step 4.

Step 4: Server Settings

In Step 4, the following R3000 server information displays: Active Directory Settings, SMTP Server Settings, Patch Server Settings, PROXY Server Settings, NTP Server Settings:

8e6 Threat Analysis Reporter

STEP 4 Server Settings

Active Directory Settings :

[Active Directory \[r3214\]](#)
 AD_Host: R3000LOGO.com
 AD_IP: 200.100.160.74
 AD_Base: DC=R3000LOGO,DC=com
 AD_Port: 0x195
 AD_Username:
 CN=Administrator,CN=Users,DC=R3000LOGO,DC=com
 AD_password: *****

SMTP Server Settings :

[SMTP \[r3214\]](#)
 SMTP_Host: popmail.LOGO.com
 SMTP_Port: 25
 SMTP_Base: false
 SMTP_DC: 50

Patch Server Settings :

[Patch Server \[r3214\]](#)
 PATCH_Server: 200.10.101.104
 PATCH_Username: prodoom
 PATCH_password: *****
 HTTPS: on
 Transfer_Mode: passive

PROXY Server Settings :

[Proxy Server \[r3214\]](#)
 PROXY_Switch: on
 PROXY_Server: 102.108.20.0
 PROXY_Username: test
 PROXY_password: *****
 PROXY_Port: 3128

NTP Server Settings :

[NTP Server \[r3214\]](#)
 NTP_Server: 102.108.20.1

PRINT LOGIN

Completed Steps 1 2 3 4

 **NOTE:** Return to Step 3 by clicking the **< BACK** button in the lower left corner of this wizard screen.

After reviewing the information in this screen, the following actions can now be performed:

- To print this information, click the **Print** button.
- To save all settings entered during the wizard process, click **Save**. After your information is saved, the login dialog box of the Threat Analysis Reporter interface displays, and you can begin using the application.

 **NOTE:** To shut down the Threat Analysis Reporter server, press the power button on the front of the unit to turn off the machine.

CONCLUSION

Congratulations; you have completed the Threat Analysis Reporter quick start procedures. Now that the Threat Analysis Reporter is running on your network, the next step is to set up user groups or administrator groups. You will set up and configure gauges thereafter.

Obtain the latest Threat Analysis Reporter User Guide from our Web site at http://www.8e6.com/docs/tar_ug.pdf.

LED INDICATORS AND BUTTONS

MSA Units

Front LED Indicators and Buttons for Hardware Status Monitoring

LED indicators and buttons for hardware status monitoring display on the front panel, located on the right side of the chassis (see diagram below).

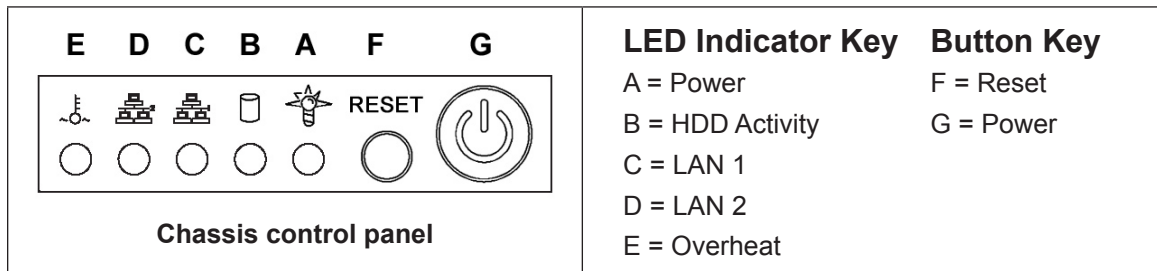

LED indicators alert you to the status of a feature on the unit while buttons let you perform a function on the unit.

LED Indicator	Color	Condition	Description
Power	Green	On	System On
		Off	System Off
HDD	Amber	Blinking	HDD Activity
		Off	No HDD Activity
LAN 1 & LAN 2	Green	On	Link Connected
		Blinking	LAN Activity
		Off	Disconnected
Overheat	Red	On	System Overheated
		Off	System Normal

REGULATORY SPECIFICATIONS AND DISCLAIMERS

Declaration of the Manufacturer or Importer

Safety Compliance

USA:	UL 60950-1 2nd ed. 2007
Europe:	Low Voltage Directive (LVD) 2006/95/EC to CB Scheme EN 60950: 2006
International:	UL/CB to IEC 60950-1:2006

Electromagnetic Compatibility (EMC)

USA:	FCC CFR 47 Part 15, Verified Class A Limit
Canada:	IC ICES-003 Class A Limit
Europe:	EMC Directive, 2004/108/EC & Low Voltage Directive (LVD) 2006/95/EC

Federal Communications Commission (FCC) Class A Notice (USA)

This equipment has been tested and found to comply with the limits for a Class A digital device, pursuant to part 15 of the FCC Rules. These limits are designed to provide reasonable protection against harmful interference when the equipment is operated in a commercial environment. This equipment generates, uses, and can radiate radio frequency energy and, if not installed and used in accordance with the instruction manual, may cause harmful interference to radio communications. Operation of this equipment in a residential area is likely to cause harmful interference in which case the user will be required to correct the interference at his own expense.

FCC Declaration of Conformity

Model: MSA-004-004

Electromagnetic Compatibility Class A Notice

Industry Canada Equipment Standard for Digital Equipment (ICES-003)

Cet appareil numérique de la classe A respecte toutes les exigences du Règlement sur le matériel brouilleur du Canada.

English translation of the notice above:

This Class A digital apparatus meets all requirements of the Canadian Interference-Causing Equipment Regulations.

EC Declaration of Conformity

European Community Directives Requirement (CE)

Declaration of Conformity

Manufacturer's Name: 8e6 Technologies
Manufacturer's Address: 828 W. Taft Avenue
Orange, CA 92865

Application of Council Directive(s): Low Voltage • 2006/95/EC
EMC • 2004/108/EC

Standard(s): Safety • EN60950: 2006
EMC • EN55022: 2006
• EN55024: 1998 +A2:2003
• EN61000-3-2: 2000
• EN61000-3-3: 2001

Product Name(s): Internet Appliance

Product Model Number(s): MSA-004-004

Year in which conformity is declared: 2008

All hardware components supplied in this unit's shipping carton are certified by our vendors to be RoHS compliant.

I, the undersigned, hereby declare that the equipment specified above conforms to the above Directive(s) and Standard(s).

Location: Orange, CA, USA

Signature:



Date: January 21, 2008

Full Name: Gregory P. Smith

Position: Director of Engineering Operations

APPENDIX: OPTIONAL ETHERNET TAP INSTALLATION

This appendix pertains to the optional installation of the Ethernet Tap unit for bandwidth monitoring.

Preliminary Setup Procedures

Unpack the Ethernet Tap Unit from the Box

Open the NetOptics Ethernet Tap box and verify that all accessories are included. Save all packing materials in the event that the unit needs to be returned to 8e6 Technologies.

The NetOptics box should contain the following items:

- 1 NetOptics 10/100BaseT Tap
- 2 Power Supply units
- 2 AC Power cords
- 2 Crossover cables
- 2 Straight through cables
- 1 Installation Guide

Other Required Installation Items

In addition to the contents of the NetOptics box, you will need the following item to install the Ethernet Tap unit:

- 1 Standard CAT-5E cable

Inspect the box for damage. If the contents appear damaged, file a damage claim with the carrier immediately.

Install the Ethernet Tap Unit

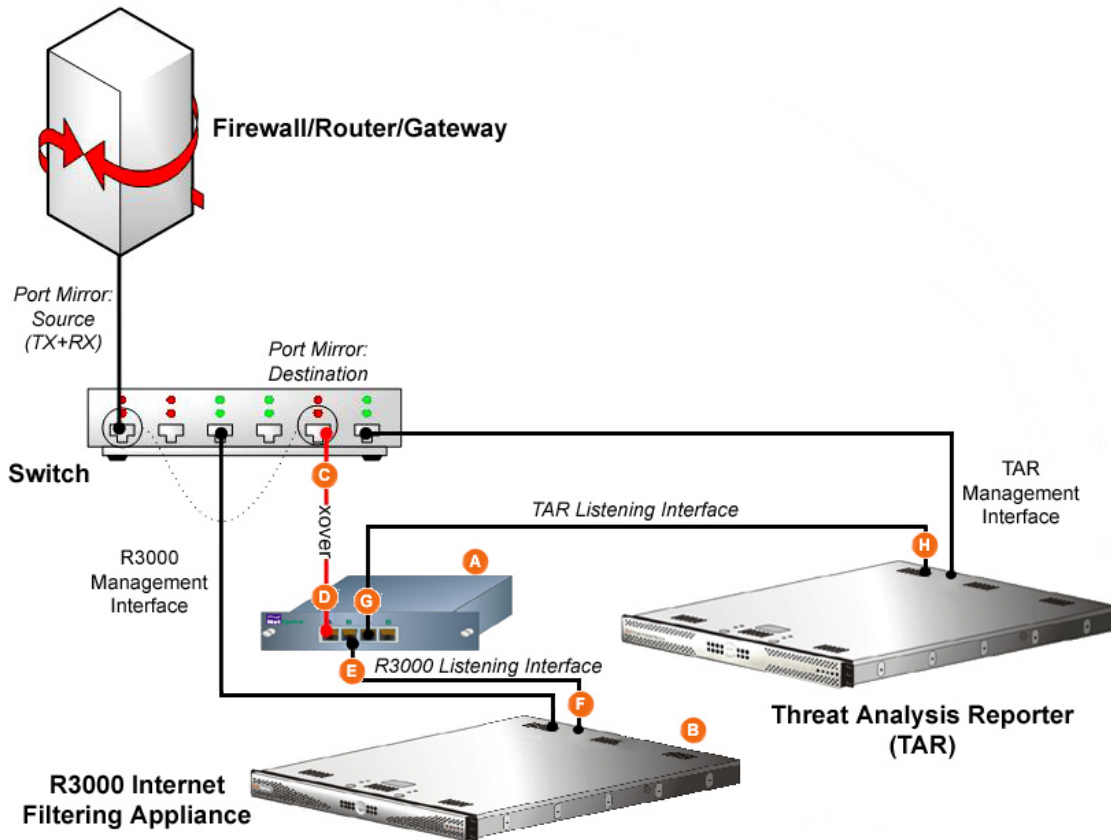

Diagram showing TAR Ethernet Tap installation on the network

This step is a continuation from Physically Connect the Unit to the Network in Step 1A or following setup in Step 1B. The procedures outlined in this step require the use of a CAT-5E cable.

- A. Provide power to the Ethernet Tap by connecting both power cords from the unit to the power source.



AC power in rear panel of NetOptics 10/100BaseT Tap

- B. If a designated source R3000 (to be used with the Threat Analysis Reporter) is already installed on the network, disconnect the cable that connects this R3000 to the switch.

If the designated R3000 has not yet been installed, disregard this sub-step and proceed to sub-step C.

- C. Using a crossover cable, connect one end to the Switch's port configured to be the destination port of the Port Mirror.

If adding a Threat Analysis Reporter to an existing installation, this port would be the port that was originally occupied by the listening interface of the R3000.

- D. Connect the other end of the crossover cable to the Ethernet Tap's Network A port.

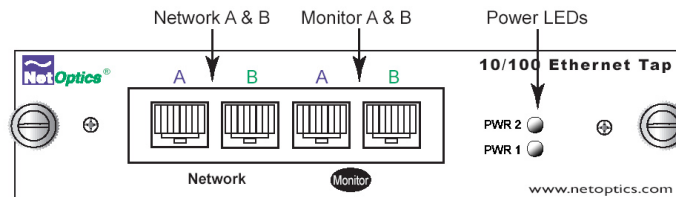

Ports in front panel of NetOptics 10/100BaseT Tap

- E. Using a straight through cable, connect one end to the Ethernet Tap's Network B port.
- F. Connect the other end of the straight through cable to the R3000's listening interface.
- G. Using the second straight through cable, connect one end to the Ethernet Tap's Monitor A port.
- H. Connect the other end of the second straight through cable to the Threat Analysis Reporter's listening interface.

Proceed to Step 2: Wizard Setup Procedures of the Threat Analysis Reporter installation instructions.

INDEX

C

crossover cable 51, 53

E

EMC 49, 50

F

FCC 49

H

HyperTerminal Setup 21

I

ICES-003 49
Install TAP 51

L

Login screen 24
LVD 49

M

MSA 20, 48, 50

P

Power Supply Precautions 15

R

R3000 1, 19, 35, 40, 41, 42, 46, 52, 53
Rack Setup Precautions 6
RoHS compliant 50

S

serial port cable 19, 20

U

UL 49

8e6 Corporate Headquarters (USA):
828 West Taft Avenue Orange, CA 92865-4232 • Tel: 714.282.6111 or 888.786.7999
Fax: 714.282.6116 (Sales/Technical Support) • 714.282.6117 (General Office)

Satellite Office:
8e6 Taiwan: 7 Fl., No. 1, Sec. 2, Ren-Ai Rd., Taipei 10055, Taiwan, R.O.C.
Tel: 886-2-2397-0300 • Fax: 886-2-2397-0306